

North Central Texas  
Council of Governments

**Recommended Amendments to the  
2021~~18~~ International Residential Code**  
North Central Texas Council of Governments Region

The following sections, paragraphs, and sentences of the 2021~~18~~ International Residential Code are hereby amended as follows: Standard type is text from the IRC. Underlined type is text inserted. ~~Lined through type is deleted text from IRC.~~ A double asterisk at the beginning of a section identifies an amendment carried over from the 2018~~15~~ edition of the code and a triple asterisk identifies a new or revised amendment with the 2021~~18~~ code.

In 2009, the State Legislature enacted SB 1410 prohibiting cities from enacting fire sprinkler mandates in residential dwellings. However, jurisdictions with ordinances that required sprinklers for residential dwellings prior to and enforced before January 1, 2009, may remain in place. Reference; Section R313 Automatic Fire Sprinkler Systems.

The energy provisions in IRC Chapter 11 is deleted in its entirety.

**Reference the 2021~~18~~ IECC for energy code provisions and recommended amendments.**

**\*\*Section R102.4; change to read as follows:**

**R102.4 Referenced codes and standards.** The codes, when specifically adopted, and standards referenced in this code shall be considered part of the requirements of this code to the prescribed extent of each such reference and as further regulated in Sections R102.4.1 and R102.4.2. Whenever amendments have been adopted to the referenced codes and standards, each reference to said code and standard shall be considered to reference the amendments as well. Any reference made to NFPA 70 or the *Electrical Code* shall mean the *Electrical Code* as adopted.

*(Reason: Legal wording to recognize locally adopted codes and amendments adopted with referenced codes.)*

**\*\* Section R103 and R103.1 amend to insert the Department Name**

**DEPARTMENT OF BUILDING SAFETY [INSERT OFFICIAL BUILDING DEPARTMENT NAME OF JURISDICTION]**

**R103.1 Creation of enforcement agency.** The ~~Department of Building Safety~~ [INSERT OFFICIAL BUILDING DEPARTMENT NAME OF JURISDICTION] is hereby created and the official in charge thereof shall be known as the *building official*.

*(Reason: Reminder to be sure ordinance reads the same as designated by the city.)*

**\*\*Section R104.10.1 Flood Hazard areas; delete this section.**

*(Reason: Flood hazard ordinances may be administered by other departments within the city.)*

**\*\*Section R105.3.1.1& R106.1.4; delete these sections.**

*(Reason: Floodplain provisions are addressed locally.)*

**\*\*Section R110 (R110.1 through R110.5); delete the section.**

*(Reason: Issuing CO's for residences is not a common practice in the area.)*

**\*\*\*Section R202; change definition of "Townhouse Unit" to read as follows:**

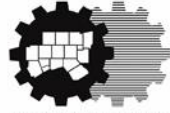

North Central Texas  
Council of Governments

**TOWNHOUSE UNIT.** A single-family dwelling unit separated by property lines in a townhouse that extends from foundation to roof and that has a yard or public way on not less than two sides.

**Commented [SL1]:** This section was crossed out on ch 3 draft document but not on the group 1 document. Which one should be followed?

(Reason: To distinguish Townhouse Units within a Townhouse building on separate lots.)

**\*\*\*Table R301.2 (1); fill in as follows:**

GROUND SNOW LOAD	WIND DESIGN				SEISMIC DESIGN CATEGORY <sup>f</sup>	SUBJECT TO DAMAGE FROM			WINTER DESIGN TEMP <sup>e</sup>	ICE BARRIER UNDER-LAYMENT <sup>h</sup>	FLOOD HAZARDS <sup>g</sup>	AIR FREEZING INDEX <sup>i</sup>	MEAN ANNUAL TEMP <sup>j</sup>
	SPEED <sup>d</sup> (MPH)	Topographic Effects <sup>k</sup>	Special Wind Region <sup>l</sup>	Windborne Debris Zone <sup>m</sup>		Weathering <sup>a</sup>	Frost Line Depth <sup>b</sup>	Termite <sup>c</sup>					
5 lb/ft	115 (3 sec-gust)/ 76 fastest mile	No	No	No	A	Moderate	6"	Very Heavy	22° F	No	Local Code	150	64.9° F

Delete remainder of table Manual J Design Criteria and footnote N

(Reason: To promote regional uniformity. Manual J is utilized by third party and not part of performed plan reviews. This is reference table only, not needed.)

**\*\*Section R302.1; add exception #6 to read as follows:**

**Exceptions:** {previous exceptions unchanged}

6. Open non-combustible carport structures may be constructed when also approved within adopted ordinances.

(Reason: Refers to other ordinances, such as zoning ordinances.)

**\*\*Section R302.3; add Exception #3 to read as follows:**

**Exceptions:**

1. {existing text unchanged}
2. {existing text unchanged}
3. Two-family dwelling units that are also divided by a property line through the structure shall be separated as required for townhouses.

(Reason: Provide guidance for a common construction method in this area. Correlates with amendment to IRC Section R202 Townhouse definition.)

**\*\*\*Section R302.2.6; delete exception #6:**

**Exceptions:** {previous exceptions unchanged}

6. ~~Townhouse units protected by a fire sprinkler system complying with Section P2904 or NFPA 43D.~~

(Reason: To remain consistent with separated townhouse units and property lines.)

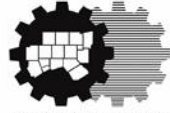

North Central Texas  
Council of Governments

**\*\*Section R302.5.1; change to read as follows:**

**R302.5.1 Opening protection.** Openings from a private garage directly into a room used for sleeping purposes shall not be permitted. Other openings between the garage and residence shall be equipped with solid wood doors not less than 13/8 inches (35 mm) in thickness, solid or honeycomb core steel doors not less than 13/8 inches (35 mm) thick, or 20-minute fire-rated doors. ~~Equipped with a self-closing or automatic closing device.~~

*(Reason: Absence of data linking self-closing devices to increased safety. Self-closing devices often fail to close the door entirely.)*

**\*\*Section R303.3, Exception; amend to read as follows:**

**Exception:** {existing text unchanged} Spaces containing only a water closet or water closet and a lavatory may be ventilated with an approved mechanical recirculating fan or similar device designed to remove odors from the air.

*(Reason: Consistent with common local practice as recirculating fans are recognized as acceptable air movement.)*

**\*\*Section R313.2 One and Two Family Dwellings; Delete this section and subsection in their entirety.**

*(Reason: In 2009, the State Legislature enacted SB 1410, amending section 1301.551 subsection I of the occupation code, prohibiting cities from enacting fire sprinkler mandates one or two family dwellings only. However, jurisdictions with ordinances that required sprinklers for one or two family dwellings prior to and enforced before January 1, 2009, may remain in place.)*

**\*\*\*Section R315.2.2 Alterations, repairs and additions; amend to read as follows:**

**Exception:**

1. [existing text remains]
2. Installation, alteration or repairs of all electrically powered mechanical systems or plumbing appliances.

*(Reason: Revised exception for clarity. Code intent is to protect against the products of combustion.)*

**\*\*Section R322 Flood Resistant Construction; deleted section.**

*(Reason: Floodplain hazard ordinances may be administered by other departments within the city.)*

**\*\*Section R401.2; amended by adding a new paragraph following the existing paragraph to read as follows.**

**Section R401.2. Requirements.** {existing text unchanged} ...

Every foundation and/or footing, or any size addition to an existing post-tension foundation, regulated by this code shall be designed and sealed by a Texas-registered engineer.

*(Amendment to 2015 IRC carried forward to 2018 IRC.)*

**\*\*Section R602.6.1; amend the following:**

**R602.6.1 Drilling and notching of top plate.** When piping or ductwork is placed in or partly in an exterior wall or interior load-bearing wall, necessitating cutting, drilling or notching of the top plate by more than 50 percent of its width, a galvanized metal tie not less than 0.054 inch thick (1.37 mm) (16 Ga) and 1-1/4 inches



North Central Texas  
Council of Governments

~~(38) mm~~ 5 inches (127 mm) wide shall be fastened across and to the plate at each side of the opening with not less than eight 10d (0.148 inch diameter) having a minimum length of 1 ½ inches (38 mm) at each side or equivalent. Fasteners will be offset to prevent splitting of the top plate material. The metal tie must extend a minimum of 6 inches past the opening. See figure R602.6.1. {remainder unchanged}

(Amendment to 2015 IRC carried forward to 2018 IRC.)

**\*\*Figure R602.6.1; delete the figure and insert the following figure:**

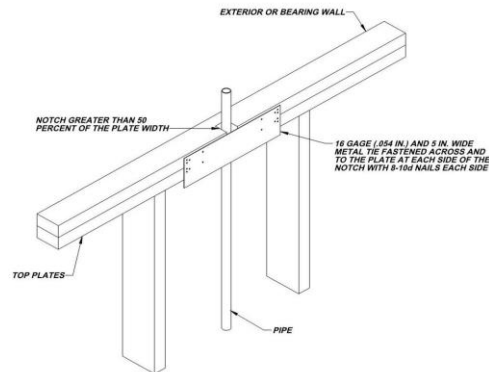

(Amendment to 2015 IRC carried forward to 2018 IRC also provides additional assurance of maintaining the integrity of the framing by spreading the nailing pattern.)

**\*\*\*Add section R703.8.4.1.2 Veneer Ties for Wall Studs; to read as follows:**

**R703.8.4.1.2 Veneer Ties for Wall Studs.** In stud framed exterior walls, all ties may be anchored to studs as follows:

1. When studs are 16 in (407 mm) o.c., stud ties shall be spaced no further apart than 24 in (737 mm) vertically starting approximately 12 in (381 mm) from the foundation; or
2. When studs are 24 in (610 mm) o.c., stud ties shall be spaced no further apart than 16 in (483 mm) vertically starting approximately 8 in (254 mm) from the foundation.

(This amendment had been a carry over amendment for years to provide clear instruction for placement of brick ties. It is now retained with changes to reflect its correct placement and use for clarity when attachment to framing lumber (studs). It should remain for those purposes. It is in addition to the new new Table in 2018 which provides for brick ties directly to sheathing.)

**\*\*Section R902.1; amend and add exception #5 to read as follows:**

**R902.1 Roofing covering materials.** Roofs shall be covered with materials as set forth in Sections R904 and R905. Class A, B, or C roofing shall be installed ~~in designated by law as requiring their use or when the edge of the roof is less than 3 feet from a lot line.~~ {remainder unchanged}

**Exceptions:**

1. {text unchanged}
2. {text unchanged}



3. {text unchanged}
4. {text unchanged}

5. Non-classified roof coverings shall be permitted on one-story detached accessory structures used as tool and storage sheds, playhouses, and similar uses, provided the floor area does not exceed (area defined by jurisdiction).

*(Reason: to address accessory structures Group U exempt from permits per Section R105.2)*

**\*\*\* Chapter 11 [RE] – Energy Efficiency is deleted in its entirety; Reference the 2018 IECC for energy code provisions and recommended amendments.**

*(Reason: The recommended energy code changes from the Energy and Green Advisory Board update the amendments for Chapter 11. The 2018 International Energy Conservation Code should be referenced for residential energy provisions. This approach simply minimizes the number of amendments to the IRC.)*

**\*\*\*Section M1305.1.2; change to read as follows:**

**M1305.1.2 Appliances in attics.** Attics containing appliances shall be provided . . . {bulk of paragraph unchanged} . . . side of the appliance. The clear access opening dimensions shall be a minimum of 20 inches by 30 inches (508 mm by 762 mm), and large enough to allow removal of the largest appliance. As a minimum, for access to the attic space, provide one of the following:

1. A permanent stair.
2. A pull down stair with a minimum 300 lb (136 kg) capacity.
3. An access door from an upper floor level.

**Exceptions:**

1. The passageway and level service space are not required where the *appliance* can be serviced and removed through the required opening.
2. Where the passageway is unobstructed...{remaining text unchanged}

*(Reason: To provide a safe means of accessibility to appliances in attics and to allow for different types of construction limitations. Consistent with regional amendment to IFGC and IMC 306.3.)*

**\*\*Section M1411.3; change to read as follows:**

**M1411.3 Condensate disposal.** Condensate from all cooling coils or evaporators shall be conveyed from the drain pan outlet to an ~~approved place of disposal~~ a sanitary sewer through a trap, by means of a direct or indirect drain. {remaining text unchanged}

*(Reason: Reflects regional practice and to reduce excessive runoff into storm drains.)*

**\*\*Section M1411.3.1, Items 3 and 4; add text to read as follows:**

**M1411.3.1 Auxiliary and secondary drain systems.** {bulk of paragraph unchanged}

1. {text unchanged}
2. {text unchanged}

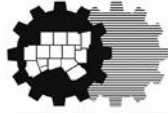

North Central Texas  
Council of Governments

3. An auxiliary drain pan... *{bulk of text unchanged}*... with Item 1 of this section. A water level detection device may be installed only with prior approval of the *building official*.
4. A water level detection device... *{bulk of text unchanged}*... overflow rim of such pan. A water level detection device may be installed only with prior approval of the *building official*.

*(Reason: Reflects standard practice in this area.)*

**\*\*Section M1411.3.1.1; add text to read as follows:**

**M1411.3.1.1 Water-level monitoring devices.** On down-flow units ...*{bulk of text unchanged}*... installed in the drain line. A water level detection device may be installed only with prior approval of the *building official*.

*(Reason: Reflects standard practice in this area.)*

**\*\*\*M1503.6 Makeup Air Required; amend and add exception as follows:**

**M1503.6 Makeup air required.** Where one or more gas, liquid or solid fuel-burning appliance that is neither direct-vent nor uses a mechanical draft venting system is located within a dwelling unit's air barrier, each exhaust system capable of exhausting in excess of 400 cubic feet per minute (0.19 m<sup>3</sup>/s) shall be mechanically or passively provided with makeup air at a rate approximately equal to the difference between exhaust air rate and 400 cubic feet per minute. Such makeup air systems shall be equipped with not fewer than one damper complying with Section M1503.6.2.

**Exception:** Makeup air is not required for exhaust systems installed for the exclusive purpose of space cooling and intended to be operated only when windows or other air inlets are open. Where all appliances in the house are of sealed combustion, power-vent, unvented, or electric, the exhaust hood system shall be permitted to exhaust up to 600 cubic feet per minute (0.28 m<sup>3</sup>/s) without providing makeup air. Exhaust hood systems capable of exhausting in excess of 600 cubic feet per minute (0.28 m<sup>3</sup>/s) shall be provided with a makeup air at a rate approximately to the difference between the exhaust air rate and 600 cubic feet per minute.

*(Reason: Exception requires makeup air equaling the amount above and beyond 400 cfm for larger fan which will address concerns related to "fresh" air from the outdoors in hot humid climates creating a burden on HVAC equipment and negative efficiency impacts from back-drafting and wasted energy.)*

**\*\*Section M2005.2; change to read as follows:**

**M2005.2 Prohibited locations.** Fuel-fired water heaters shall not be installed in a room used as a storage closet. Water heaters located in a bedroom or bathroom shall be installed in a sealed enclosure so that combustion air will not be taken from the living space. Access to such enclosure may be from the bedroom or bathroom when through a solid door, weather-stripped in accordance with the exterior door air leakage requirements of the *International Energy Conservation Code* and equipped with an *approved self-closing device*. Installation of direct-vent water heaters within an enclosure is not required.

*(Reason: Corresponds with the provisions of IFGC Section 303.3, exception #5.)*

**\*\*Section G2408.3 (305.5) Private Garages; delete this section in its entirety.**

*(Reason: This provision does not reflect standard practice in this area.)*

**\*\*Section G2415.2.1 (404.2.1) CSST; add a second paragraph to read as follows:**

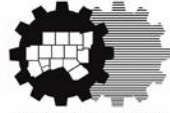

North Central Texas  
Council of Governments

Both ends of each section of medium pressure gas piping shall identify its operating gas pressure with an approved tag. The tags are to be composed of aluminum or stainless steel and the following wording shall be stamped into the tag:

"WARNING: 1/2 to 5 psi gas pressure - Do Not Remove"

*(Reason: To protect homeowners and plumbers.)*

**\*\*\*Section G2415.12 (404.12) and G2415.12.1 (404.12.1); change to read as follows:**

**G2415.12 (404.12) Minimum burial depth.** Underground *piping systems* shall be installed a minimum depth of ~~42 inches (305 mm)~~ 18 inches (457 mm) below grade, ~~except as provided for in Section G2415.12.1.~~

**G2415.12.1 (404.12.1) Individual Outdoor Appliances; Delete in its entirety**

*(Reason: To provide increased protection to piping systems.)*

**\*\*Section G2417.1 (406.1); change to read as follows:**

**G2417.1 (406.1) General.** Prior to acceptance and initial operation, all *piping* installations shall be inspected and *pressure tested* to determine that the materials, design, fabrication, and installation practices comply with the requirements of this *code*. The *permit* holder shall make the applicable tests prescribed in Sections 2417.1.1 through 2417.1.5 to determine compliance with the provisions of this *code*. The *permit* holder shall give reasonable advance notice to the *building official* when the *piping system* is ready for testing. The *equipment*, material, power and labor necessary for the inspections and test shall be furnished by the *permit* holder and the *permit* holder shall be responsible for determining that the work will withstand the test pressure prescribed in the following tests.

*(Reason: To utilize language used in the IPC regarding who is responsible for testing procedures.)*

**\*\*Section G2417.4; change to read as follows:**

**G2417.4 (406.4) Test pressure measurement.** Test pressure shall be measured with a monometer or with a pressure-measuring device designed and calibrated to read, record, or indicate a pressure loss caused by leakage during the pressure test period. The source of pressure shall be isolated before the pressure tests are made. ~~Mechanical gauges used to measure test pressures shall have a range such that the highest end of the scale is not greater than five times the test pressure.~~

*(Reason: To require the use of more accurate diaphragm gauges. Spring gauges do not provide accurate measurement below approximately 17 psig.)*

**\*\*Section G2417.4.1; change to read as follows:**

**G2417.4.1 (406.4.1) Test pressure.** The test pressure to be used shall be no less than 3 psig (20 kPa gauge), ~~or at the discretion of the Code Official, the piping and valves may be tested at a pressure of at least six (6) inches (152 mm) of mercury, measured with a manometer or slope gauge, irrespective of design pressure. Where the test pressure exceeds 125 psig (862 kPa gauge), the test pressure shall not exceed a value that produces a hoop stress in the piping greater than 50 percent of the specified minimum yield strength of the pipe.~~ For tests requiring a pressure of 3 psig, diaphragm gauges shall utilize a dial with a minimum diameter of three and one half inches (3 1/2"), a set hand, 1/10 pound incrementation and pressure range not to exceed 6 psi for tests requiring a pressure of 3 psig. For tests requiring a pressure of 10 psig, diaphragm gauges shall utilize a dial with a minimum diameter of three and one-half inches (3 1/2"), a set hand, a minimum of 2/10 pound incrementation and a pressure range not to exceed 20 psi. For welded piping, and for piping carrying gas at pressures in excess of fourteen (14) inches water column pressure (3.48 kPa) (1/2 psi) and less than 200 inches of water column pressure (52.2 kPa) (7.5 psi), the



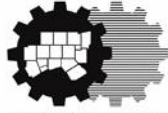

North Central Texas  
Council of Governments

test pressure shall not be less than ten (10) pounds per square inch (69.6 kPa). For piping carrying gas at a pressure that exceeds 200 inches of water column (52.2 kPa) (7.5 psi), the test pressure shall be not less than one and one-half times the proposed maximum working pressure.

Diaphragm gauges used for testing must display a current calibration and be in good working condition. The appropriate test must be applied to the diaphragm gauge used for testing

*(Reason: To provide for lesser pressures to coordinate with the use of more accurate diaphragm gauges.)*

**\*\*Section G2417.4.2; change to read as follows:**

**G2417.4.2 (406.4.2) Test duration.** The test duration shall be held for a length of time satisfactory to the Building Official, but in no case for be not less than 15 fifteen (15) minutes. For welded piping, and for piping carrying gas at pressures in excess of fourteen (14) inches water column pressure (3.48 kPa), the test duration shall be held for a length of time satisfactory to the Building Official, but in no case for less than thirty (30) minutes.

*(Reason: To comply with accepted regional practices.)*

**\*\*Section G2420.1 (406.1); add Section G2420.1.4 to read as follows:**

**G2420.1.4 Valves in CSST installations.** Shutoff valves installed with corrugated stainless steel (CSST) piping systems shall be supported with an approved termination fitting, or equivalent support, suitable for the size of the valves, of adequate strength and quality, and located at intervals so as to prevent or damp out excessive vibration but in no case greater than 12-inches from the center of the valve. Supports shall be installed so as not to interfere with the free expansion and contraction of the system's piping, fittings, and valves between anchors. All valves and supports shall be designed and installed so they will not be disengaged by movement of the supporting piping.

*(Reason: To provide proper security to CSST valves. These standards were established in this region in 1999 when CSST was an emerging technology.)*

**\*\*Section G2420.5.1 (409.5.1); add text to read as follows:**

**G2420.5.1 (409.5.1) Located within the same room.** The shutoff valve...{bulk of paragraph unchanged}... in accordance with the appliance manufacturer's instructions. A secondary shutoff valve must be installed within 3 feet (914 mm) of the firebox if appliance shutoff is located in the firebox.

*(Reason: Reflects regional practice and provides an additional measure of safety.)*

**\*\*Section G2421.1 (410.1); add text and Exception to read as follows:**

**G2421.1 (410.1) Pressure regulators.** A line pressure regulator shall be ... {bulk of paragraph unchanged}... approved for outdoor installation. Access to regulators shall comply with the requirements for access to appliances as specified in Section M1305.

**Exception:** A passageway or level service space is not required when the regulator is capable of being serviced and removed through the required attic opening.

*(Reason: To require adequate access to regulators.)*

**\*\*Section G2422.1.2.3 (411.1.3.3) Prohibited locations and penetrations; delete Exception 1 and Exception 4.**

*(Reason: To comply with accepted regional practices.)*



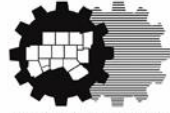

North Central Texas  
Council of Governments

**\*\*Section G2445.2 (621.2); add Exception to read as follows:**

**G2445.2 (621.2) Prohibited use.** One or more *unvented room heaters* shall not be used as the sole source of comfort heating in a *dwelling unit*.

**Exception:** Existing *approved unvented room heaters* may continue to be used in *dwelling units*, in accordance with the *code provisions in effect when installed, when approved by the Building Official unless an unsafe condition is determined to exist as described in International Fuel Gas Code Section 108.7 of the Fuel Gas Code.*

*(Reason: Gives code official discretion.)*

**\*\*Section G2448.1.1 (624.1.1); change to read as follows:**

**G2448.1.1 (624.1.1) Installation requirements.** The requirements for *water heaters* relative to access, sizing, relief valves, drain pans and scald protection shall be in accordance with this *code*.

*(Reason: To clarify installation requirements. Also corresponds with amendments regarding water heater access.)*

**\*\*\*Section P2603; add to read as follows:**

**P2603.3 Protection against corrosion.** Metallic piping, except for cast iron, ductile iron and galvanized steel, shall not be placed in direct contact with steel framing members, concrete or cinder walls and floors or other masonry. Metallic piping shall not be placed in direct contact with corrosive soil. Where sheathing is used to prevent direct contact, the sheathing shall have a thickness of not less than 0.008 inch (8 mil) (0.203 mm) and the sheathing shall be made of approved material plastic. Where sheathing protects piping that penetrates concrete or masonry walls or floors, the sheathing shall be installed in a manner that allows movement of the piping within the sheathing.

*(Reason: Allows for other materials to be accepted.)*

**\*\*\*Section P2603.5.1 Sewer Depth; change to read as follows:**

**P2603.5.1 Sewer depth.** Building sewers that connect to private sewage disposal systems shall be a minimum of [number] inches (mm) below finished grade at the point of septic tank connection. Building sewers shall be a minimum of 12 inches (304 mm) below grade.

*(Reason: Provides sewer depth that is common in this region. Deleted reference to private sewage disposal because a private sewage disposal code is not typically adopted in this region.)*

**\*\*\*Section P2604; add to read as follows:**

**P2604.2.1 Plastic sewer and DWV piping installation.** Plastic sewer and DWV piping installed underground shall be installed in accordance with the manufacturer's installation instructions. Trench width shall be controlled to not exceed the outside the pipe diameter plus 16 inches or in a trench which has a controlled width equal to the nominal diameter of the piping multiplied by 1.25 plus 12 inches. The piping shall be bedded in 4 inches of granular fill and then backfilled compacting the side fill in 6-inch layers on each side of the piping. The compaction shall be to minimum of 85 percent standard proctor density and extend to a minimum of 6 inches above the top of the pipe.

*(Reason: To follow manufacturer backfill requirements and to be clear to Inspectors out in the field.)*

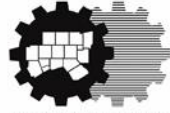

North Central Texas  
Council of Governments

**\*\*\* Section P2801; change to read as follows:**

**P2801.6 Required pan.**

Where a storage tank-type water heater or a hot water storage tank is installed in a location where water leakage from the tank will cause damage, the tank shall be installed in a pan constructed of one of the following:

1. Galvanized steel or aluminum of not less than 0.0236 inch (0.6010 mm) in thickness.
2. Plastic not less than 0.036 inch (0.9 mm) in thickness.
3. Other *approved* materials.

~~A plastic pan beneath a gas-fired water heater shall be constructed of material having a flame spread index of 25 or less and a smoke-developed index of 450 or less when tested in accordance with ASTM E84 or UL-723.~~

*(Reason: Plastic burns degrading material over time on gas fired water heaters and to maintaining protection level.)*

**\*\*Section P2801.6.1; change to read as follows:**

**Section P2801.6.1 Pan size and drain.** The pan shall be not less than 1 1/2 inches (38 mm) in depth and shall be of sufficient size and shape to receive all dripping or condensate from the tank or water heater. The pan shall be drained by an indirect waste pipe having a diameter of not less than 3/4 inch (19 mm). Piping for safety pan drains shall be of those materials listed in Table P2906.5.

Multiple pan drains may terminate to a single discharge piping system when approved by the administrative authority and permitted by the manufactures installation instructions and installed with those instructions.  
*{existing text unchanged}*

*(Reason: Regionally accepted practice.)*

**\*\*\* Section P2804.6.1; change to read as follows:**

**Section P2804.6.1 Requirements for discharge piping.** The discharge piping serving a pressure relief valve, temperature relief valve or combination thereof shall:

1. Not be directly connected to the drainage system.
2. Discharge through an air gap located in the same room as the water heater.
3. Not be smaller than the diameter of the outlet of the valve served and shall discharge full size to the air gap.
4. Serve a single relief device and shall not connect to piping serving any other relief device or equipment.

Exception: Multiple relief devices may be installed to a single T & P discharge piping system when approved by the administrative authority and permitted by the manufactures installation instructions and installed with those instructions.

5. Discharge to the floor, to the pan serving the water heater or storage tank, to a waste receptor an approved location or to the outdoors.

[remainder unchanged]

*(Reason: To ensure the T&P is ran to the exterior.)*

**\*\*Section P2902.5.3; change to read as follows:**



**P2902.5.3 Lawn irrigation systems.** The potable water supply to lawn irrigation systems shall be protected against backflow by an atmospheric-type vacuum breaker, a pressure-type vacuum breaker, a double-check assembly or a reduced pressure principle backflow preventer. A valve shall not be installed downstream from an atmospheric vacuum breaker. Where chemicals are introduced into the system, the potable water supply shall be protected against backflow by a reduced pressure principle backflow preventer.

*(Reason: To provide clarity.)*

**\*\*\*Section P3003.9; change to read as follows:**

**P3003.9.2 Solvent cementing.** Joint surfaces shall be clean and free from moisture. A purple primer that conforms to ASTM F 656 shall be applied. Solvent cement not purple in color and conforming to ASTM D 2564, CSA B137.3, CSA B181.2 or CSA B182.1 shall be applied to all joint surfaces. The joint shall be made while the cement is wet and shall be in accordance with ASTM D 2855. Solvent cement joints shall be permitted above or below ground.

Exception: A primer is not required where both of the following conditions apply:

1. The solvent cement used is third-party certified as conforming to ASTM D 2564
2. The solvent cement is used only for joining PVC drain, waste, and vent pipe and fittings in not pressure applications in sizes up to and including 4 inches (102mm) in diameter.

*(Reason: to keep the "process of joining PVC pipe".)*

**\*\*Section P3111Combination waste and vent systems; delete this section in its entirety.**

*(Reason: A combination waste and vent system is not approved for use in residential construction.)*

**\*\*Section P3112.2 Vent Collection; delete and replace with the following:**

**P3112.2 Installation.** Traps for island sinks and similar equipment shall be roughed in above the floor and may be vented by extending the vent as high as possible, but not less than the drainboard height and then returning it downward and connecting it to the horizontal sink drain immediately downstream from the vertical fixture drain. The return vent shall be connected to the horizontal drain through a wye-branch fitting and shall, in addition, be provided with a foot vent taken off the vertical fixture vent by means of a wye-branch immediately below the floor and extending to the nearest partition and then through the roof to the open air or may be connected to other vents at a point not less than six (6) inches (152 mm) above the flood level rim of the fixtures served. Drainage fittings shall be used on all parts of the vent below the floor level and a minimum slope of one-quarter (1/4) inch per foot (20.9 mm/m) back to the drain shall be maintained. The return bend used under the drain-board shall be a one (1) piece fitting or an assembly of a forty-five (45) degree (0.79 radius), a ninety (90) degree (1.6 radius) and a forty-five (45) degree (0.79 radius) elbow in the order named. Pipe sizing shall be as elsewhere required in this Code. The island sink drain, upstream of the return vent, shall serve no other fixtures. An accessible cleanout shall be installed in the vertical portion of the foot vent.

*(Reason: To clarify the installation of island venting and to provide a regional guideline on a standard installation method for this region.)*

**END**